

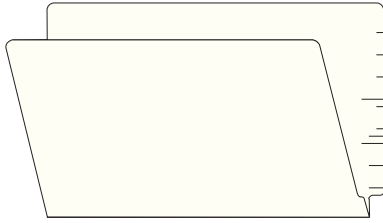

McLENNAN & COMPANY

FILING & STORAGE SYSTEMS LTD.

FILE FOLDERS



8789

LEGAL SIZE FOLDER IN 10.5 pt. CANADIAN MANILA
Full reinforced end tab with undercut
Straight cut top tab
(Transition Folder)
15-1/4" x 9-1/2"

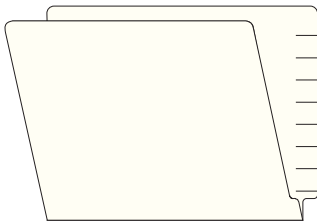

8788

LETTER SIZE FOLDER IN 10.5 pt. CANADIAN MANILA
Full reinforced end tab with undercut
12-1/4" x 9-1/2"

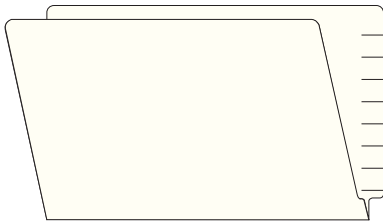

M27210

LEGAL SIZE FOLDER IN 14 pt. CANADIAN MANILA
Full reinforced end tab with undercut
15-1/4" x 9-1/2"

M24210

LETTER SIZE FOLDER IN 14 pt. CANADIAN MANILA
Full reinforced end tab with undercut
12-1/4" x 9-1/2"

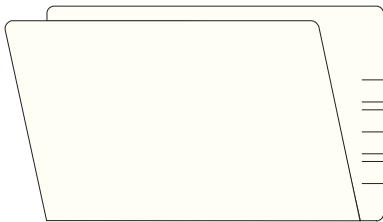

M1228

LEGAL SIZE FOLDER IN 14 pt. CANADIAN MANILA
Full reinforced end tab (no undercut)
15-1/4" x 9-1/2"
* ALSO AVAILABLE IN PEARL WHITE (M1228PW)

M1224

LETTER SIZE FOLDER IN 14 pt. CANADIAN MANILA
Full reinforced end tab (no undercut)
12-1/4" x 9-1/2"

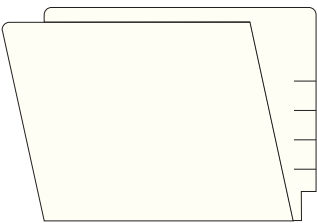

M1257

METRIC SIZE FOLDER IN 14 pt. CANADIAN PEARL WHITE
Full reinforced end tab with undercut
13" x 9-1/2" (33cm x 24cm)

NOTE! Most Metro Folders are made from recycled stock

Phone: (780) 451- 2900 Fax: (780) 451-8013

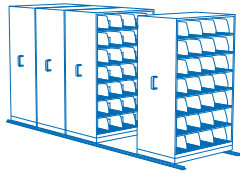

McLENNAN & COMPANY

FILING & STORAGE SYSTEMS LTD.

FILE FOLDERS

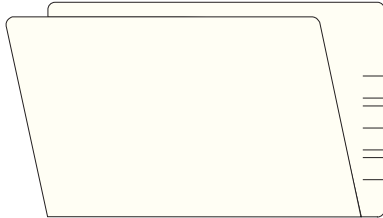

3217 MYLAR

LEGAL SIZE FOLDER IN 14 pt. CDN. WHITE MANILLA
Full reinforced end tab. Folder body laminated with mylar.
15-1/4" x 9-1/2"

3116 MYLAR

LETTER SIZE FOLDER IN 14 pt. CDN. WHITE MANILLA
Full reinforced end tab. Folder body laminated with mylar.
12-1/4" x 9-1/2"

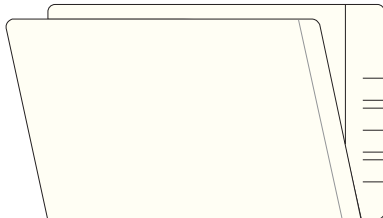

3217 MYLAR
3116 MYLAR

LEGAL/LETTER FOLDER IN 14 pt. CDN. WHITE MANILLA
Coloured end tab, Mylar laminated body, reinforced full
end tab. 15-1/4" x 9-1/2"

COLOURS

- | | |
|---------------------|-------------------|
| 3217-0 - Pink | 3217-6 - Lt. Blue |
| 3217-1 - Red | 3217-7 - Purple |
| 3217-2 - Orange | 3217-8 - Lavender |
| 3217-3 - Dk. Orange | 3217-9 - Brown |
| 3217-4 - Lt. Green | 3217-10 - Yellow |
| 3217-5 - Dk. Green | |

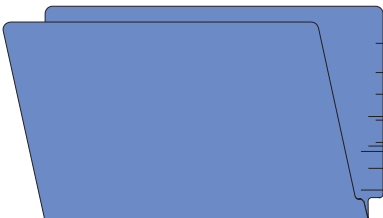

A98TD

LEGAL SIZE COLORED FOLDER IN 13.5 pt. CANADIAN STOCK
Full reinforced end tab with undercut
15-1/4" x 9-1/2"

- | | |
|----------------------|--------------------|
| A98TD BL - Blue | A98TD OG - Orange |
| A98TD GN - Green | A98TD PK - Pink |
| A98TD TQ - Turquoise | A98TD RED - Red |
| A98TD GR - Grey | A98TD WH - White |
| A98TD LV - Lavender | A98TD YEL - Yellow |

A88TD

LETTER SIZE COLORED FOLDER IN 13.5 pt. CANADIAN STOCK
Full reinforced end tab with undercut
12-1/4" x 9-1/2"

- | | |
|----------------------|--------------------|
| A88TD BL - Blue | A88TD OG - Orange |
| A88TD GN - Green | A88TD PK - Pink |
| A88TD TQ - Turquoise | A88TD RED - Red |
| A88TD GR - Grey | A88TD WH - White |
| A88TD LV - Lavender | A88TD YEL - Yellow |

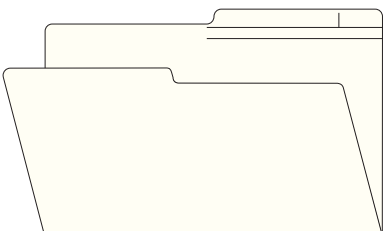

15345

LEGAL SIZE FOLDER IN 11 pt. MANILA
Half cut top tab two-ply reversible
14-3/4" x 9-1/2"

10345

LETTER SIZE FOLDER IN 11 pt. MANILA
Half cut top tab two-ply reversible
11-3/4" x 9-1/2"

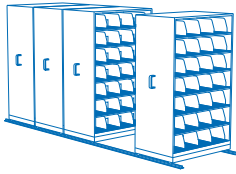

McLENNAN & COMPANY

FILING & STORAGE SYSTEMS LTD.

END TAB PRESSBOARD

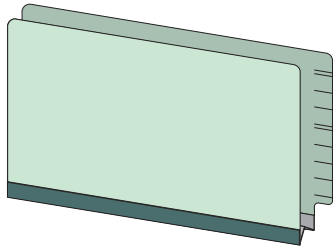

374112 LEGAL SIZE CANADIAN GREEN PRESSBOARD FOLDER
Full end tab with undercut
1" Expansion
15-1/4" x 9-1/2" (14-1/4" Body)
100 / BOX

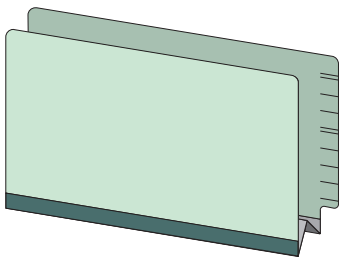

7890M LEGAL SIZE CANADIAN GREEN PRESSBOARD FOLDER
Full end tab with undercut
2" Expansion (3" available)
15-1/4" x 9-1/2" (14-1/4" Body)
100 / BOX

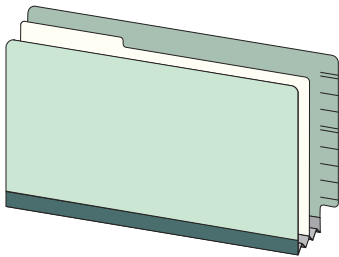

50915 LEGAL SIZE CANADIAN GREEN PRESSBOARD FOLDER
Full end tab with undercut
Classification folder complete with
1 Insert & 4 Fasteners
2" Expansion
15-3/4" x 9-1/2" (14-1/4" Body)
100 / BOX

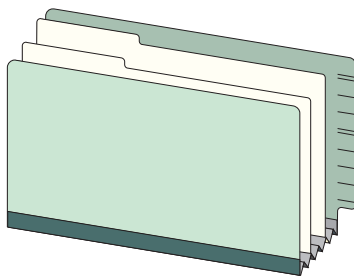

E617 LEGAL SIZE CANADIAN GREEN PRESSBOARD FOLDER
Full end tab with undercut
Classification folder complete with
2 Inserts & 6 Fasteners
3" Expansion
15-1/4" x 9-1/2" (14-1/4" Body)
50 / BOX

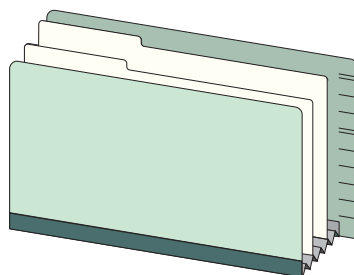

E618 LEGAL SIZE CANADIAN GREEN PRESSBOARD FOLDER
Full end tab with NO undercut
Classification folder complete with
2 Insert & 6 Fasteners
3" Expansion
15-1/4" x 9-1/2" (14-1/4" Body)
50 / BOX

Phone: (780) 451- 2900 Fax: (780) 451-8013

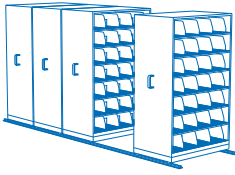

McLENNAN & COMPANY

FILING & STORAGE SYSTEMS LTD.

WELL FILE POCKETS

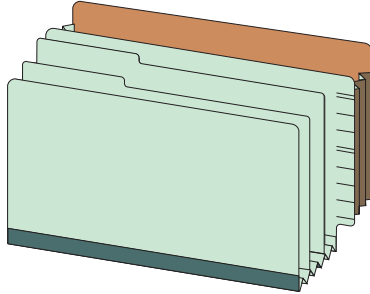

E617W

LEGAL SIZE CANADIAN GREEN PRESSBOARD FOLDER
Full end tab with undercut
Classification folder complete with
2 Inserts & 6 Fasteners
Attached to 1526 top tab 3-1/2" expansion pocket
50 / BOX

NOTE ! LOG POCKETS AVAILABLE

TOP TAB PRESSBOARD

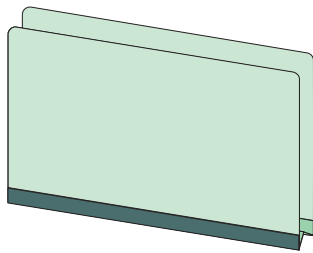

E600P

LEGAL SIZE CANADIAN GREEN PRESSBOARD FOLDER
Straight cut top tab
1" Expansion (2" & 3" available)
14-3/4" x 9-1/2" (9" Body)
100 / BOX

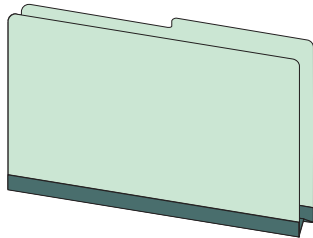

E602P

LEGAL SIZE CANADIAN GREEN PRESSBOARD FOLDER
Half cut top tab
1" Expansion (2" & 3" available)
14-3/4" x 9-1/2" (9" Body)
100 / BOX

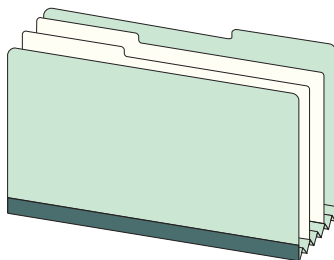

E607

LEGAL SIZE CANADIAN GREEN PRESSBOARD FOLDER
One third cut top tab
Classification folder complete with
2 Inserts & 6 Fasteners
3" Expansion
14-3/4" x 9-1/2" (9-1/2" Body)
50 / BOX

NOTE !

Colours are also available in American Genuine
Pressboard.

Letter size folders are also available.

Phone: (780) 451- 2900 Fax: (780) 451-8013



McLENNAN & COMPANY

FILING & STORAGE SYSTEMS LTD.

EXPANSION POCKETS

FULL END TAB WITH STRAIGHT CUT TOP TAB

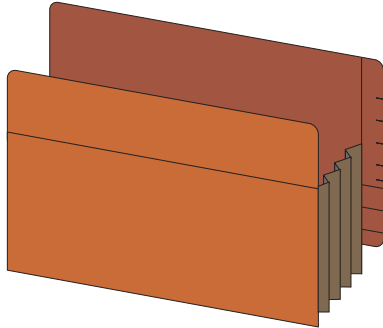

LEGAL

EXPANSION	GUSSET		
	PAPER	TYVEK	QTY/BOX
1-3/4"	FST 1516	FST 1516 TYV	50
3-1/2"	FST 1526	FST 1526 TYV	25
5-1/4"	FST 1536	FST 1536 TYV	25
3-1/2"		DP86014 *	25
4"		M1844 *	50

EXPANSION	GUSSET		
	PAPER	TYVEK	QTY/BOX
1-3/4"	FST 1514	FST 1514 TYV	50
3-1/2"	FST 1524	FST 1524 TYV	25
5-1/4"	FST 1534	FST 1534 TYV	25
4"		M1842 *	50

LETTER

* NO UNDERCUT ON TAB

ADD "MBO" TO ITEM # FOR
MANILLA BACKS

STRAIGHT CUT TOP TAB

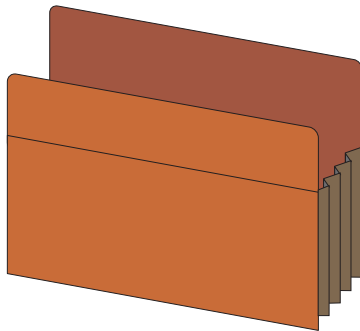

LEGAL

EXPANSION	GUSSET		
	PAPER	TYVEK	QTY/BOX
1-3/4"	1516	1516 TYV	50
3-1/2"	B1526E	1526 TYV	P/50 T/25
5-1/4"	1536	1536 TYV	25

LETTER

EXPANSION	GUSSET		
	PAPER	TYVEK	QTY/BOX
1-3/4"	1514	1514 TYV	50
3-1/2"	1524	1524 TYV	25
5-1/4"	1534	1534 TYV	25

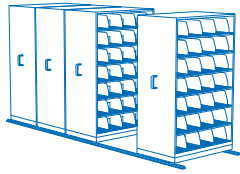

McLENNAN & COMPANY

FILING & STORAGE SYSTEMS LTD.

MISCELLANEOUS FILING SUPPLIES

MEDICAL SUPPLIES

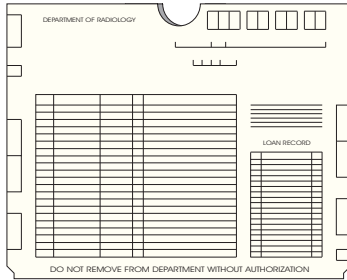

XJ4010

X-RAY JACKET c/w KANGAROO POCKET
Any style jacket or printing available
Closed 3 sides

NOTE: CATEGORY INSERTS ARE ALSO AVAILABLE

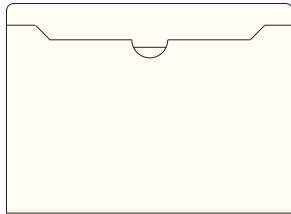

76900

DENTAL POCKET - FOR X-RAYS & DOCUMENTS
Letter size jacket in 11 pt. American Manila
Closed 3 sides
9-1/2" x 11-3/4"
100 / BOX

GUIDES



LEGAL SIZE FILE GUIDE IN CANADIAN GREEN PRESSBOARD
Full end tab (no undercut)
15-3/4" x 9-1/2"

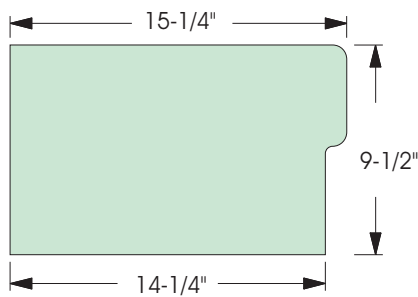

NOTE! All file guides are available in sizes suited to your needs. Available materials range from fusion and index papers to tag manila and genuine pressboard. PLEASE CALL FOR A QUOTE.

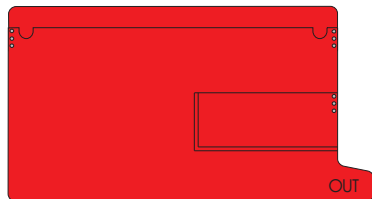

DB-176
CENTRE TAB

LEGAL SIZE OUT GUIDE IN 15 pt. RED VINYL
Bottom or centre position end tab
16-1/4" x 9" overall (15" body)
Large pocket 14-3/4" x 8-3/8"
Card size pocket 6-3/8 x 3-1/4"

DB-179
BOTTOM TAB

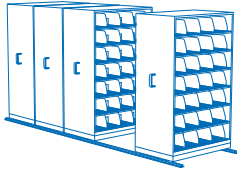

McLENNAN & COMPANY

FILING & STORAGE SYSTEMS LTD.

MISCELLANEOUS FILING SUPPLIES

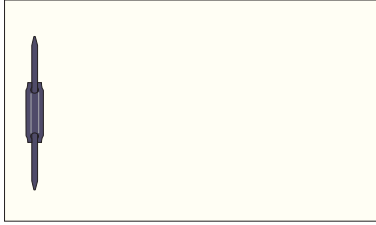

File Backs

Made to order
Legal or letter size file backs

FASTENERS



Permclip

Permanent heat-sealed fasteners applied to any type folder
2" Capacity
We apply for you



Grip Clip

Self-adhesive fasteners - simply peel off back and apply
2" Capacity
100 / BOX



TY1 Patch

Self-adhesive tyvek tip-back patch
For use with build-em-up fasteners (sold separately)
We apply for you

FASTENER POSITIONS

END TAB

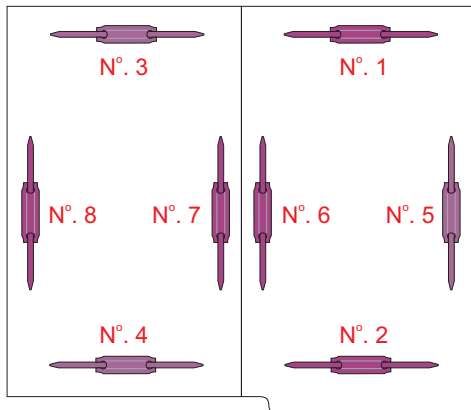

TOP TAB

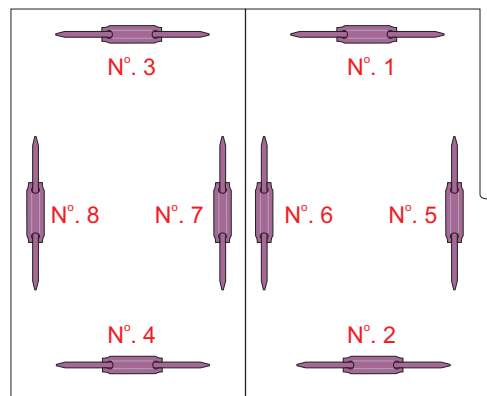

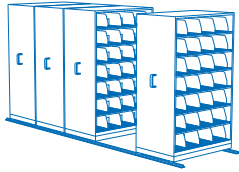

McLENNAN & COMPANY

FILING & STORAGE SYSTEMS LTD.

MISCELLANEOUS FILING SUPPLIES

SELF ADHESIVE PRODUCTS



68123 2" X3"

68185 8" x 5" (shown)

68164 6" x 4"

68153 5" x 3"

SELF-ADHESIVE VINYL POCKETS
Simply peel off backing and apply
White backing with clear front
Other sizes available

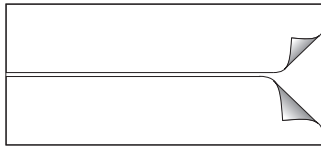

MYLAR PROTECTOR LABELS (clear)
Use to protect non-mylar labels or reinforce
folder spines. Peel off backing and apply
3-1/2" x 1-3/4" (other sizes available)
500 / BOX

LABEL BLOCK-OUT STOCK
White or manila coloured self-adhesive
strips which allow for re-labeling over
existing labels
500 / BOX

#9006	2" x 6"	500/box
#9009	2" x 9"	500/box
#1775 white	2" x 9"	500/roll
#1775 manila	2" x 9"	500/roll
#1776 white	2" x 8 1/4"	500/roll
#1776 manila	2" x 8 1/4"	500/roll

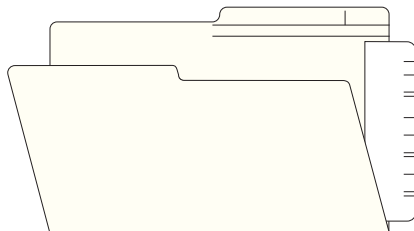

9165
EN-TAB

Use to convert top tab folders to end tab
Simply peel off backing and apply

55993
EXTEND
A
TAB

Use to convert top tab pockets to end tab